

20" Scroll Saw

(Model 40-680)

P • 20



Record this information for future reference.

SERIAL NO. _____

DATE OF PURCHASE _____

See Table of Contents for location of Serial No.

DATED 11-20-98

PART NO. 1342405
© Delta International Machinery Corp. 1998



DELTA

TABLE OF CONTENTS

SAFETY RULES	3
ADDITIONAL SAFETY RULES FOR SCROLL SAWS	4
UNPACKING AND CLEANING	5
ASSEMBLY INSTRUCTIONS	6
Assembling Stand	6
Fastening Scroll Saw To Stand	7
Assembling Rear Leg Height Extension	8
Assembling Holddown Foot	8
Rotating Table To 90 Degree Position	8
Assembling Table Insert	8
CONNECTING SCROLL SAW TO POWER SOURCE	9
Extension Cords	9
Grounding Instructions	9
FASTENING STAND TO SUPPORTING SURFACE	10
OPERATING CONTROLS AND ADJUSTMENTS	10
On-Off Power Switch	10
Locking On-Off Power Switch	10
Cutting Speeds	10
Changing Cutting Speeds	10
Dust Blower	11
Adjusting Blade Tension	11
Adjusting Clamping Action Of Blade Holders	12
Adjusting Holddown	12
Changing Blades	12
Tilting The Table	13
Adjusting 90 And 45 Degree Positive Stops For Table	14
Aligning Lower Blade Holder With Upper Blade Holder	15
LUBRICATION	15
DUST COLLECTION	16
INSIDE CUTTING	16
BLADE BREAKAGE	17
CHOICE OF BLADE AND SPEED	17
APPLICATIONS	18
ZERO-CLEARANCE TABLE INSERT	19
SERIAL NUMBER LOCATION	19
PARTS, SERVICE, OR WARRANTY ASSISTANCE	20
WARRANTY	20

SAFETY RULES

Woodworking can be dangerous if safe and proper operating procedures are not followed. As with all machinery, there are certain hazards involved with the operation of the product. Using the machine with respect and caution will considerably lessen the possibility of personal injury. However, if normal safety precautions are overlooked or ignored, personal injury to the operator may result. Safety equipment such as guards, push sticks, hold-downs, featherboards, goggles, dust masks and hearing protection can reduce your potential for injury. But even the best guard won't make up for poor judgment, carelessness or inattention. Always use common sense and exercise caution in the workshop. If a procedure feels dangerous, don't try it. Figure out an alternative procedure that feels safer. REMEMBER: Your personal safety is your responsibility.

This machine was designed for certain applications only. Delta Machinery strongly recommends that this machine not be modified and/or used for any application other than that for which it was designed. If you have any questions relative to a particular application, DO NOT use the machine until you have first contacted Delta to determine if it can or should be performed on the product.

DELTA INTERNATIONAL MACHINERY CORP.
MANAGER OF TECHNICAL SERVICES
246 ALPHA DRIVE
PITTSBURGH, PENNSYLVANIA 15238
(IN CANADA: 644 IMPERIAL ROAD, GUELPH, ONTARIO N1H 6M7)

WARNING: FAILURE TO FOLLOW THESE RULES MAY RESULT IN SERIOUS PERSONAL INJURY

- 1. FOR YOUR OWN SAFETY, READ INSTRUCTION MANUAL BEFORE OPERATING THE TOOL.** Learn the tool's application and limitations as well as the specific hazards peculiar to it.
- 2. KEEP GUARDS IN PLACE** and in working order.
- 3. ALWAYS WEAR EYE PROTECTION.**
- 4. REMOVE ADJUSTING KEYS AND WRENCHES.** Form habit of checking to see that keys and adjusting wrenches are removed from tool before turning it "on."
- 5. KEEP WORK AREA CLEAN.** Cluttered areas and benches invite accidents.
- 6. DON'T USE IN DANGEROUS ENVIRONMENT.** Don't use power tools in damp or wet locations, or expose them to rain. Keep work area well-lighted.
- 7. KEEP CHILDREN AND VISITORS AWAY.** All children and visitors should be kept a safe distance from work area.
- 8. MAKE WORKSHOP CHILDPROOF** – with padlocks, master switches, or by removing starter keys.
- 9. DON'T FORCE TOOL.** It will do the job better and be safer at the rate for which it was designed.
- 10. USE RIGHT TOOL.** Don't force tool or attachment to do a job for which it was not designed.
- 11. WEAR PROPER APPAREL.** No loose clothing, gloves, neckties, rings, bracelets, or other jewelry to get caught in moving parts. Nonslip footwear is recommended. Wear protective hair covering to contain long hair.
- 12. ALWAYS USE SAFETY GLASSES.** Wear safety glasses. Everyday eyeglasses only have impact resistant lenses; they are not safety glasses. Also use face or dust mask if cutting operation is dusty.
- 13. SECURE WORK.** Use clamps or a vise to hold work when practical. It's safer than using your hand and frees both hands to operate tool.
- 14. DON'T OVERREACH.** Keep proper footing and balance at all times.
- 15. MAINTAIN TOOLS IN TOP CONDITION.** Keep tools sharp and clean for best and safest performance. Follow instructions for lubricating and changing accessories.
- 16. DISCONNECT TOOLS** before servicing and when changing accessories such as blades, bits, cutters, etc.
- 17. USE RECOMMENDED ACCESSORIES.** The use of accessories and attachments not recommended by Delta may cause hazards or risk of injury to persons.
- 18. REDUCE THE RISK OF UNINTENTIONAL STARTING.** Make sure switch is in "OFF" position before plugging in power cord.
- 19. NEVER STAND ON TOOL.** Serious injury could occur if the tool is tipped or if the cutting tool is accidentally contacted.
- 20. CHECK DAMAGED PARTS.** Before further use of the tool, a guard or other part that is damaged should be carefully checked to ensure that it will operate properly and perform its intended function – check for alignment of moving parts, binding of moving parts, breakage of parts, mounting, and any other conditions that may affect its operation. A guard or other part that is damaged should be properly repaired or replaced.
- 21. DIRECTION OF FEED.** Feed work into a blade or cutter against the direction of rotation of the blade or cutter only.
- 22. NEVER LEAVE TOOL RUNNING UNATTENDED. TURN POWER OFF.** Don't leave tool until it comes to a complete stop.
- 23. DRUGS, ALCOHOL, MEDICATION.** Do not operate tool while under the influence of drugs, alcohol or any medication.
- 24. MAKE SURE TOOL IS DISCONNECTED FROM POWER SUPPLY** while motor is being mounted, connected or re-connected.
- 25. WARNING:** The dust generated by certain woods and wood products can be injurious to your health. Always operate machinery in well ventilated areas and provide for proper dust removal. Use wood dust collection systems whenever possible.

ADDITIONAL SAFETY RULES FOR SCROLL SAWS

1. **WARNING:** Do not operate your scroll saw until it is completely assembled and installed according to the instructions.
2. **IF YOU ARE NOT** thoroughly familiar with the operation of Scroll Saws, obtain advice from your supervisor, instructor or other qualified person.
3. **YOUR SCROLL SAW STAND MUST** be fastened to the floor if there is any tendency for the stand to move during operation.
4. **THIS SCROLL SAW** is intended for indoor use only.
5. **MAKE SURE** blade is properly tensioned before operating saw.
6. **TO AVOID** blade breakage **ALWAYS** adjust blade tension correctly.
7. **MAKE SURE** the blade teeth point downward toward the table.
8. **NEVER** turn the saw "ON" before clearing the table of all objects (tools, scraps of wood, etc.).
9. **DO NOT** cut material that is too small to be safely supported.
10. **AVOID** awkward hand positions where a sudden slip could cause a hand to move into the blade.
11. **ALWAYS** keep hands and fingers away from blade.
12. **ALWAYS** adjust holddown foot for each new operation.
13. **DO NOT USE** dull or bent blades.
14. **DO NOT** attempt to saw material that does not have a flat surface, unless a suitable support is used.
15. **MAKE** "relief" cuts before cutting long curves.
16. **NEVER** attempt to cut a curve that is too tight for the blade being used.
17. **WHEN** backing a blade out of a workpiece, the blade may bind in the saw kerf. This is usually caused by sawdust in the kerf. If this happens, turn "**OFF**" the switch and remove plug from power source outlet. Wedge open the kerf and back blade out of the workpiece.
18. **ALWAYS** hold the work firmly against the table.
19. **DO NOT** feed the material too fast while cutting. Only feed the material fast enough so that the blade will cut.
20. **NEVER** start the Scroll Saw with the stock pressed against the blade.
21. **WHEN** cutting a large workpiece **MAKE SURE** the material is supported at table height.
22. **USE CAUTION** when cutting material which is irregular in cross section which could pinch the blade before the cut is completed. A piece of moulding for example must lay flat on the table and not be permitted to rock while being cut.
23. **USE CAUTION** when cutting round material such as dowel rods or tubing. They have a tendency to roll while being cut causing the blade to "bite." Use a V-block to control the piece.
24. **ALWAYS** release blade tension before loosening the blade holder.
25. **MAKE CERTAIN** table tilting lock is tightened before starting the machine.
26. **NEVER** reach under the table while the machine is running.
27. **NEVER** perform layout, assembly or set-up work on the table while the saw is operating.
28. **ALWAYS STOP** the saw before removing scrap pieces from the table.
29. **SHOULD** any part of your Scroll Saw be missing, damaged or fail in any way, or any electrical component fail to perform properly, shut off switch and remove plug from power supply outlet. Replace missing, damaged or failed parts before resuming operation.
30. **ADDITIONAL INFORMATION** regarding the safe and proper operation of this product is available from the National Safety Council, 1121 Spring Lake Drive, Itasca, IL 60143-3201, in the Accident Prevention Manual for Industrial Operations and also in the Safety Data Sheets provided by the NSC. Please also refer to the American National Standards Institute ANSI 01.1 Safety Requirements for Woodworking Machinery and the U.S. Department of Labor OSHA 1910.213 Regulations.
31. **SAVE THESE INSTRUCTIONS.** Refer to them frequently and use them to instruct other users.

UNPACKING AND CLEANING

Your new scroll saw and stand is shipped complete in one container. Carefully unpack the saw, stand and all loose items from the shipping container. Figure 2 illustrates the saw and all loose items and Figure 3 illustrates the stand and all related parts. Remove the protective coating from the saw table surface. This coating may be removed with a soft cloth moistened with kerosene (do not use acetone, gasoline or lacquer thinner for this purpose). After cleaning, cover the table surface with a good quality paste wax. Buff out the wax thoroughly to prevent it from rubbing into your workpieces.

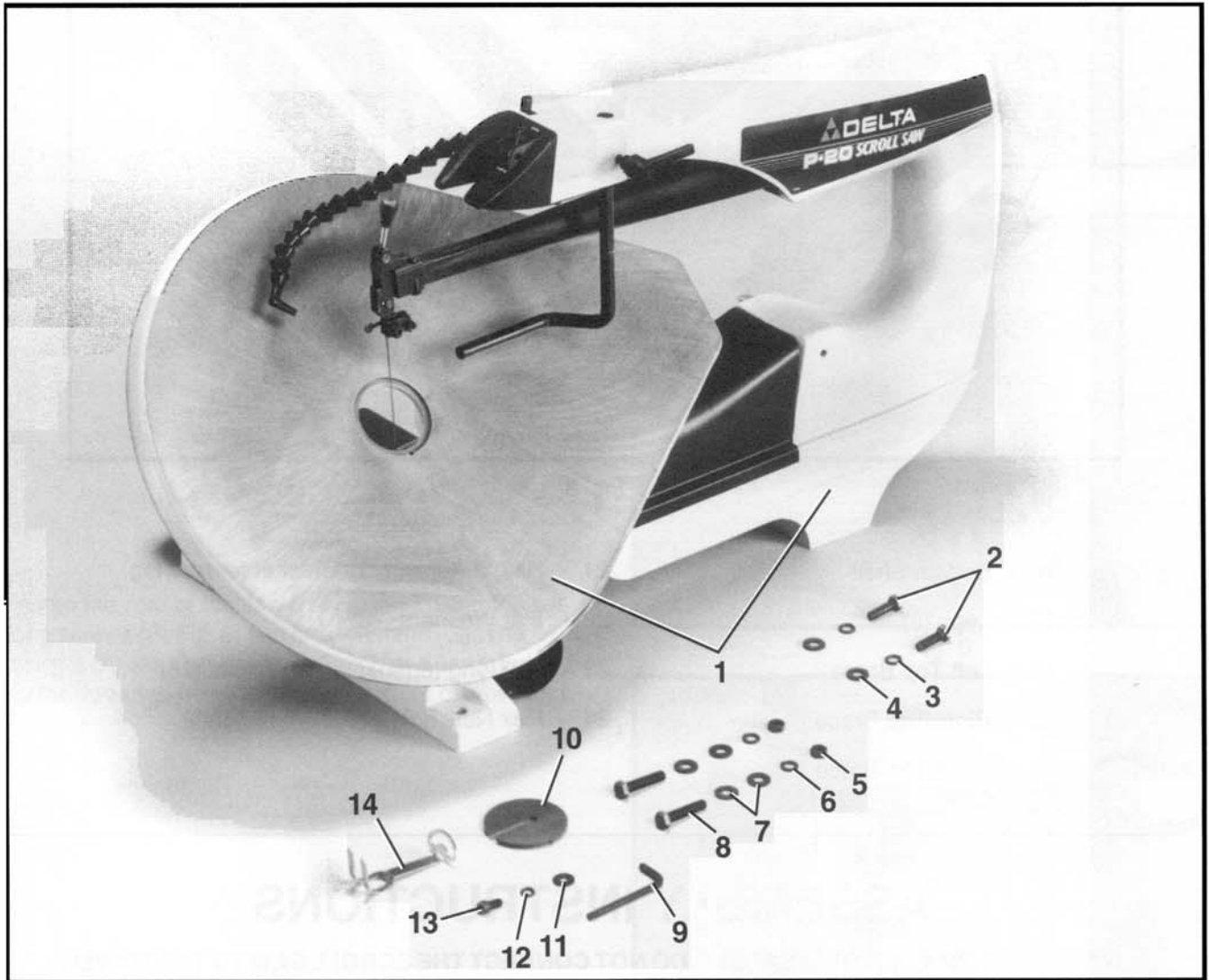

Fig. 2

- | | |
|---|---|
| 1 - Scroll Saw | 8 - 5/16"-18 x 1-1/2" hex head screw - for fastening front of saw to stand (2) |
| 2 - 5/16"-18 x 5/8" long hex head screws - for fastening rear of saw to stand (2) | 9 - 5mm hex wrench |
| 3 - 5/16" lockwashers - for fastening rear of saw to stand (2) | 10 - Table insert |
| 4 - 5/16" flat washers - for fastening rear of saw to stand (2) | 11 - M6 flatwasher - for fastening holddown foot to holddown bar |
| 5 - 5/16"-18 hex nut - for fastening front of saw to stand (2) | 12 - 1/4" lockwasher - for fastening holddown foot to holddown bar |
| 6 - 5/16" lockwasher - for fastening front of saw to stand (2) | 13 - 1/4" - 20 x 1/2" hex socket head screw - for fastening holddown foot to holddown bar |
| 7 - 5/16" flat washer - for fastening front of saw to stand (4) | 14 - Holddown foot |
| | 15 - Zero-clearance table insert (not shown) |

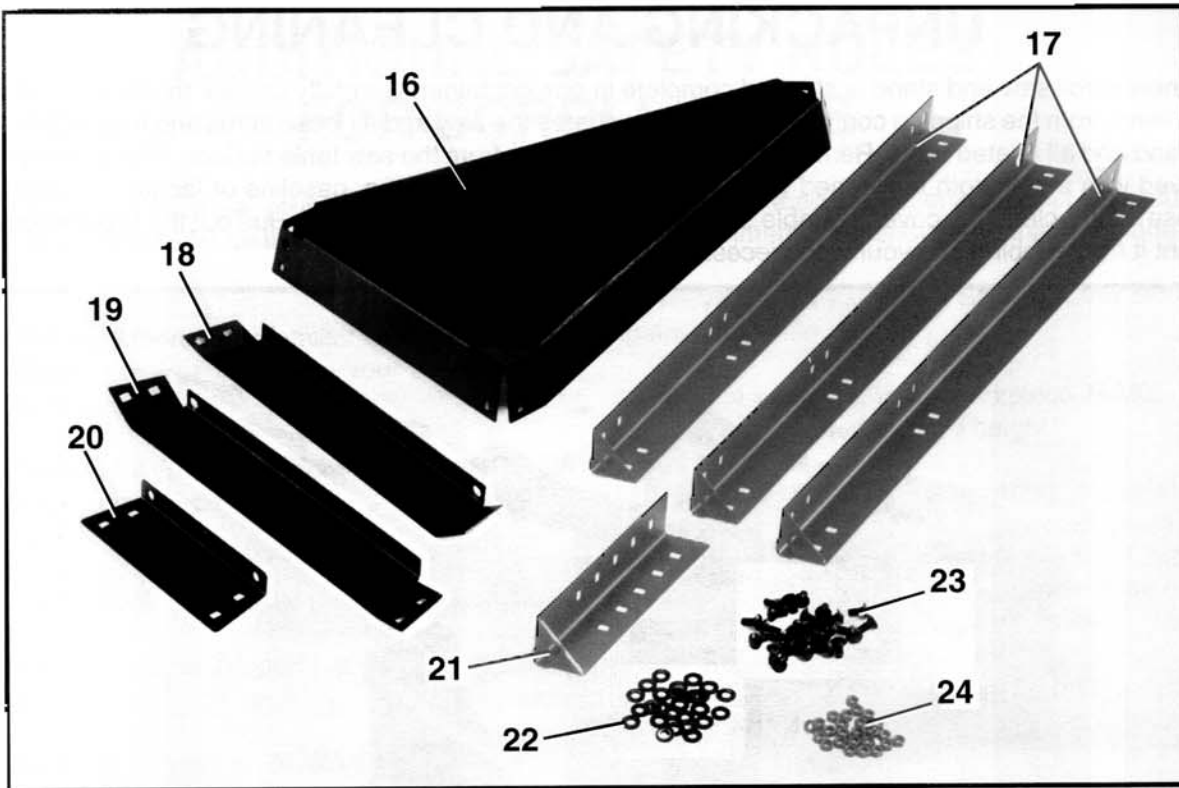

Fig. 3

- | | |
|----------------------|---|
| 16 - Bottom Shelf | 21 - Height Adjustment Bracket for rear leg |
| 17 - Legs (3) | 22 - Flat Washers (28) |
| 18 - Left Top Brace | 23 - 5/8" long (8mm) Carriage Bolts (28) |
| 19 - Right Top Brace | 24 - Hex Nuts (28) |
| 20 - Front Top Brace | |

ASSEMBLY INSTRUCTIONS

WARNING: FOR YOUR OWN SAFETY, DO NOT CONNECT THE SCROLL SAW TO THE POWER SOURCE UNTIL THE MACHINE IS COMPLETELY ASSEMBLED AND YOU HAVE READ AND UNDERSTOOD THE ENTIRE OWNERS MANUAL.

ASSEMBLING STAND

1. Assemble the stand, as shown in Fig. 4, using the 24 carriage bolts, flat washers and hex nuts. **NOTE:** The round holes on the top of the two top braces (A) are to be positioned toward the rear leg (B) and all three legs are positioned outside the bottom shelf and top braces. **DO NOT TIGHTEN STAND MOUNTING HARDWARE AT THIS TIME.**

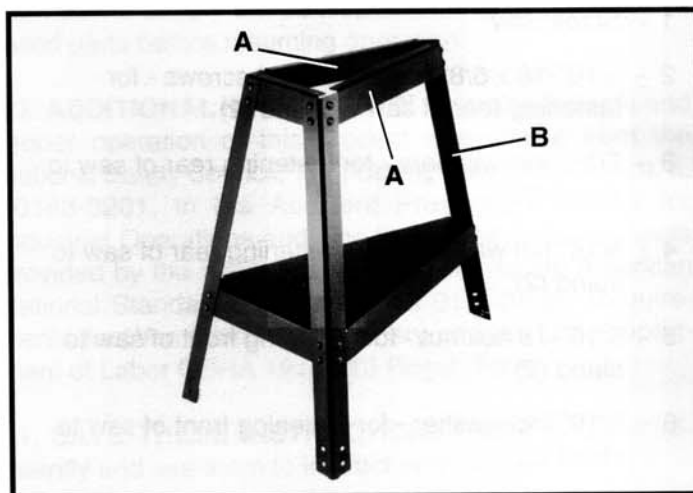

Fig. 4

FASTENING SCROLL SAW TO STAND

1. Place scroll saw on top braces of stand and fasten front of saw to top front brace using the two 1-1/2" long screws (A) Fig. 5, flat washers (B) and two flat washers (C), lock washers (D) and hex nuts (E) from below.

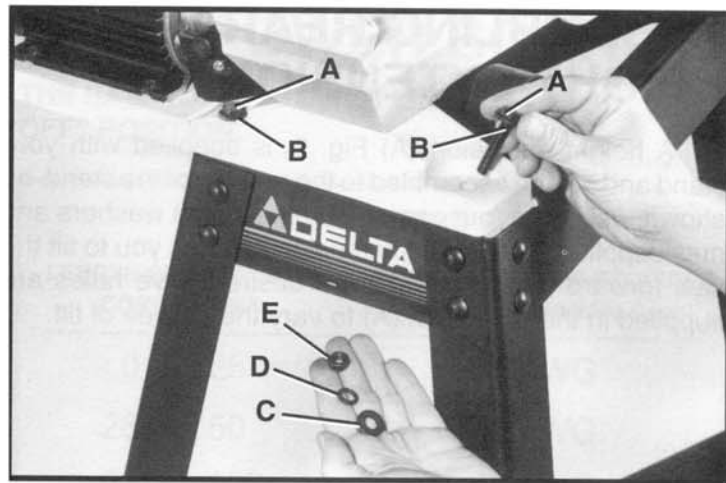

Fig. 5

2. Fasten the rear of the saw to the stand using the two 5/8" long screws (F) Fig. 6, and lock washers (G). The 5/8" long screws (F) are also shown in Fig. 7, and are threaded up into the threaded holes located on bottom of saw base.

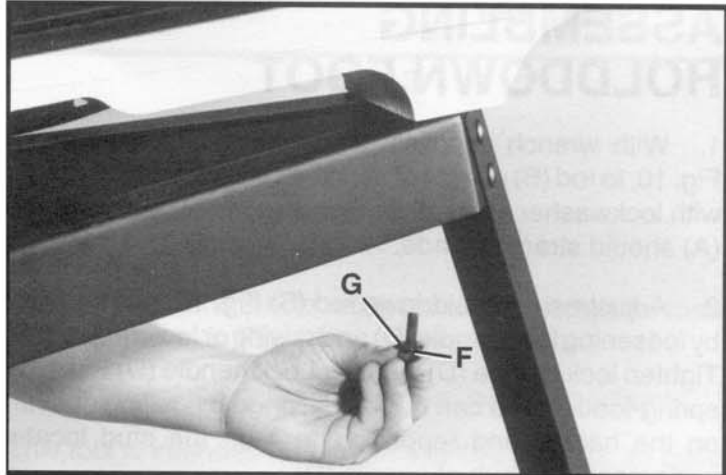
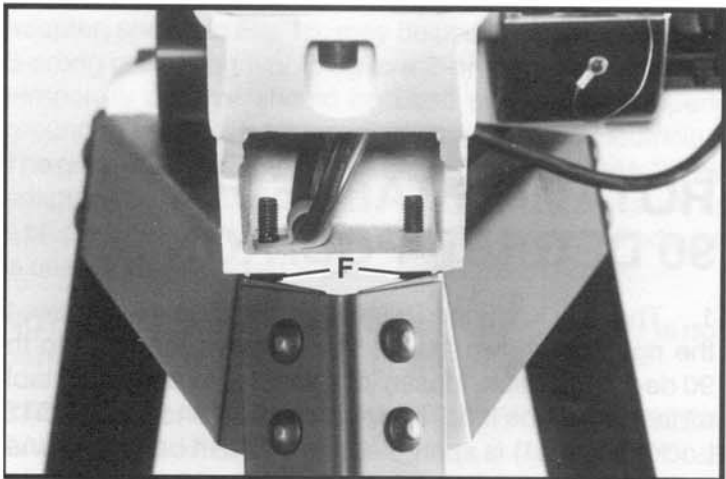
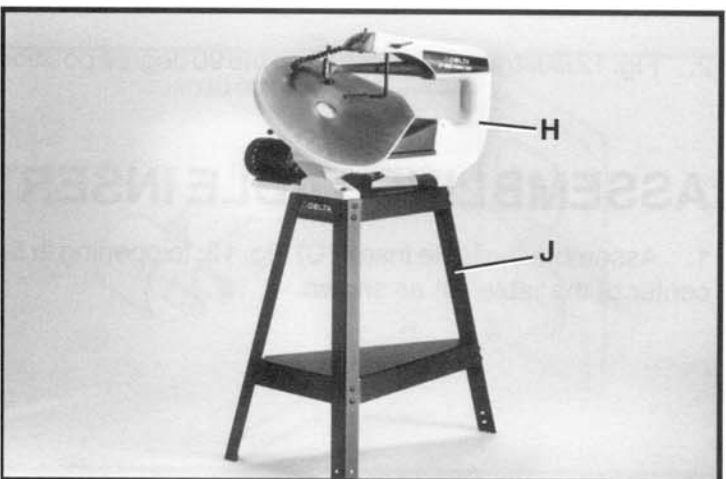

Fig. 6



3. Figure 8 illustrates the saw (H) fastened to the stand (J). Place the stand on a level surface and securely tighten all stand mounting hardware.



ig. 8

ASSEMBLING REAR LEG HEIGHT EXTENSION

1. A height extension (A) Fig. 9, is supplied with your stand and can be assembled to the rear leg of the stand, as shown, using the four carriage bolts (B), flat washers and nuts supplied. The height extension enables you to tilt the saw forward during operation if desired. Five holes are supplied in the extension (A) to vary the degree of tilt.

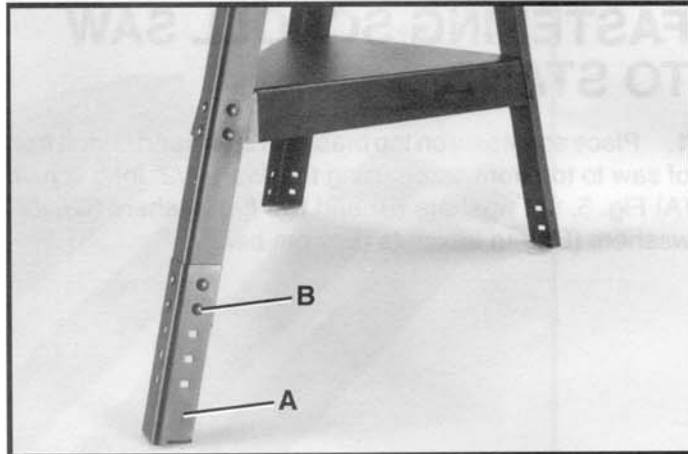

Fig. 9

ASSEMBLING HOLDDOWN FOOT

1. With wrench supplied, assemble holddown foot (A) Fig. 10, to rod (B) using 1/2" long hex socket head screw (C) with lockwasher and flat washer. Prongs of holddown foot (A) should straddle blade.

2. Adjustment to holddown rod (B) Fig. 10, can be made by loosening lock handle (D) and raising or lowering rod (B). Tighten lock handle (D). **NOTE:** Lock handle (D) Fig.10, is spring-loaded and can be repositioned by pulling outward on the handle and repositioning it on the stud located underneath the hub of handle (D).

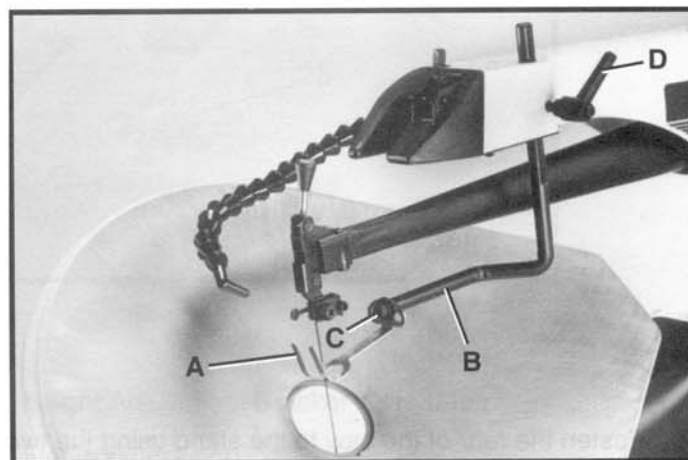

Fig. 10

ROTATING TABLE TO 90 DEGREE POSITION

1. The saw is shipped with the table tilted 45 degrees to the right, as shown in Fig. 11. To move the table to the 90 degree position, loosen lock handle (A) and rotate table all the way to the left. Then tighten lock handle (A). **NOTE:** Lock handle (A) is spring-loaded and can be repositioned by pulling out the handle and repositioning it on the stud located underneath the hub of the handle.

2. Fig. 12 illustrates the table (B) in the 90 degree position.



Fig. 11

ASSEMBLING TABLE INSERT

1. Assemble the table insert (C) Fig. 12, to opening in the center of the table (B) as shown.

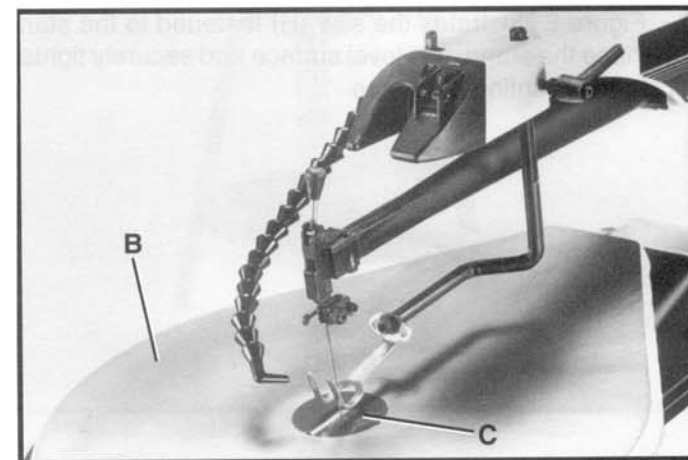

Fig. 12

CONNECTING SCROLL SAW TO POWER SOURCE

IMPORTANT: BEFORE CONNECTING THE SAW TO THE POWER LINE, MAKE SURE THE SWITCH IS IN THE "OFF" POSITION.

EXTENSION CORDS

The use of any extension cord will cause some loss of power. To keep this loss to a minimum, make sure the extension cord is in good condition and is a 3-wire extension cord which has a 3-prong grounding type plug and a 3-pole receptacle which will accept the tool's plug. When using an extension cord, be sure to use one heavy enough to carry the current of the scroll saw. An undersized cord will cause a drop in line voltage resulting in loss of power and overheating. Fig. 13, shows the correct size to use depending on cord length. If in doubt, use the next heavier gage. The smaller the gage number, the heavier the cord.

EXTENSION CORD SIZE	
LENGTH OF EXTENSION CORD IN FEET	120 VOLT WIRE SIZE REQUIRED (AWG - American Wire Gage)
0 - 25	18 AWG
26 - 50	16 AWG
51 - 100	16 AWG
101 - 150	14 AWG

Fig. 13

GROUNDING INSTRUCTIONS

CAUTION: THIS TOOL MUST BE GROUNDED WHILE IN USE TO PROTECT THE OPERATOR FROM ELECTRIC SHOCK.

In the event of a malfunction or breakdown, grounding provides a path of least resistance for electric current to reduce the risk of electric shock. This tool is equipped with an electric cord having an equipment-grounding conductor and a grounding plug. The plug must be plugged into a matching outlet that is properly installed and grounded in accordance with all local codes and ordinances.

Do not modify the plug provided - if it will not fit the outlet, have the proper outlet installed by a qualified electrician.

Improper connection of the equipment-grounding conductor can result in risk of electric shock. The conductor with insulation having an outer surface that is green with or without yellow stripes is the equipment-grounding conductor. If repair or replacement of the electric cord or plug is necessary, do not connect the equipment grounding conductor to a live terminal.

Check with a qualified electrician or service personnel if the grounding instructions are not completely understood, or if in doubt as to whether the tool is properly grounded.

Use only 3-wire extension cords that have 3-prong ground-

ing type plugs and 3-hole receptacles that accept the tool's plug, as shown in Fig. 14.

Repair or replace damaged or worn cord immediately.

This tool is intended for use on a circuit that has an outlet and a plug that looks like the one shown in Fig. 14. If a properly grounded outlet is not available, a temporary adapter, shown in Fig. 15, may be used for connecting the 3-prong grounding type plug to a 2-prong receptacle. The temporary adapter should be used only until a properly grounded outlet can be installed by a qualified electrician. The green colored rigid ear, lug, or the like extending from the adapter must be connected to a permanent ground such as a properly grounded outlet box cover. Whenever the adapter is used, it must be held in place with a metal screw.

NOTE: In Canada, the use of a temporary adapter is not permitted by the Canadian Electric Code.

CAUTION: IN ALL CASES, MAKE CERTAIN THE RECEPTACLE IN QUESTION IS PROPERLY GROUNDED. IF YOU ARE NOT SURE HAVE A CERTIFIED ELECTRICIAN CHECK THE RECEPTACLE.

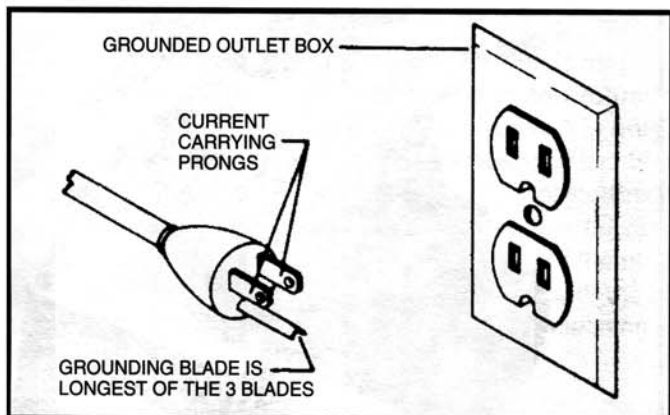

Fig. 14

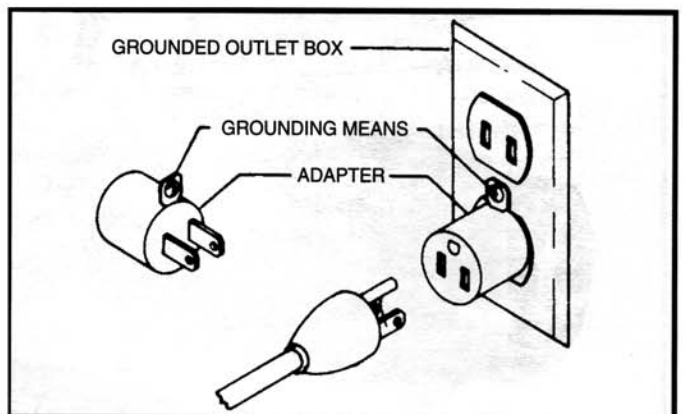

Fig. 15

FASTENING STAND TO SUPPORTING SURFACE

If there is any tendency for the scroll saw to move during operation, the scroll saw stand must be fastened to the floor.

OPERATING CONTROLS AND ADJUSTMENTS

ON-OFF POWER SWITCH

The on-off switch (A) Fig. 16, is located on the top of the arm, as shown. To turn the saw "ON" push down on the "ON" portion of the switch and to turn the saw "OFF" push down on the "OFF" portion of the switch.

LOCKING ON-OFF SWITCH IN "OFF" POSITION

IMPORTANT: We suggest that when the scroll saw is not in use, the on-off switch be locked in the "OFF" position using a padlock (B), as shown in Fig. 17. Available as an accessory from Delta is the 50-325 padlock, shown at (B).

CUTTING SPEEDS

Six cutting speeds of 400, 700, 1200, 1400, 1600, and 2000 strokes per minute are available with the 20" Scroll Saw. The convenient chart (A) Fig. 18, located on top belt cover (B) illustrates which steps of the pulley the belt must be located to obtain the six speeds of the 20" Scroll Saw.



Fig. 16

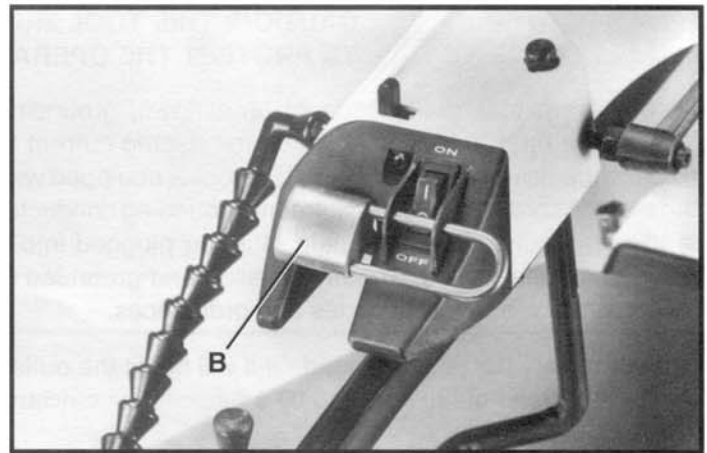

Fig. 17

CHANGING CUTTING SPEEDS

1. DISCONNECT THE MACHINE FROM THE POWER SOURCE.
2. To change the cutting speed of the scroll saw, rotate knob (C) Fig. 18, clockwise to disengage latch (D) from screw (E) and lift top cover (A) as shown.
3. Carefully move belt (G) Fig. 19, to the smaller of the desired pulleys by grasping the belt and rotating the pulleys as shown. Then move the belt to the larger of the desired pulleys.
4. Replace top cover (A) Fig. 18.

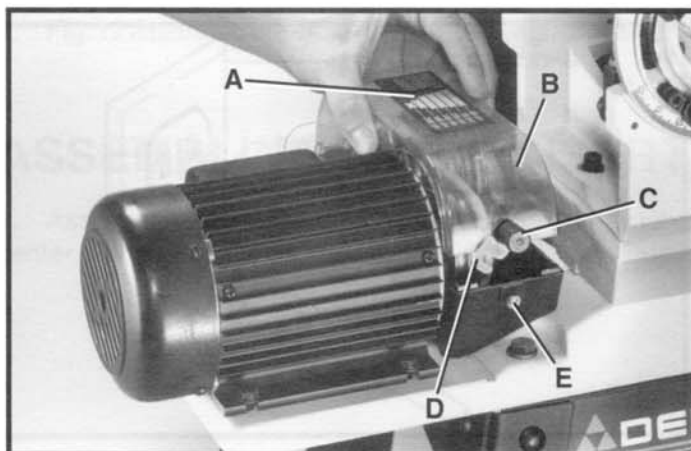

Fig. 18

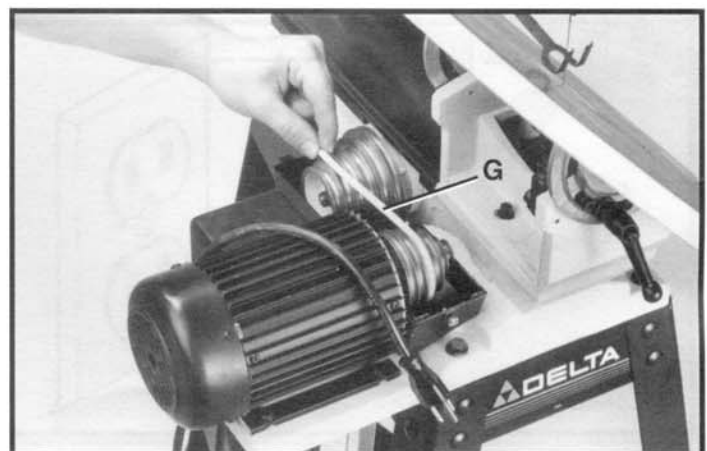

Fig. 19

DUST BLOWER

A dust blower (A) Fig. 20, is provided, and can be moved to direct air to the most effective point on the cutting line.

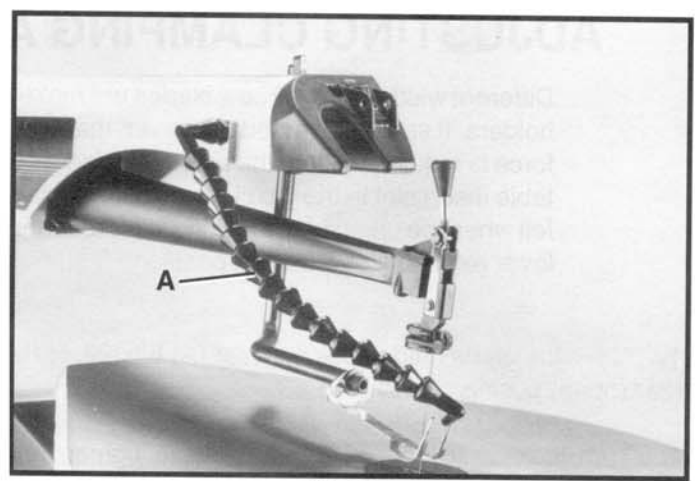

Fig. 20

ADJUSTING BLADE TENSION

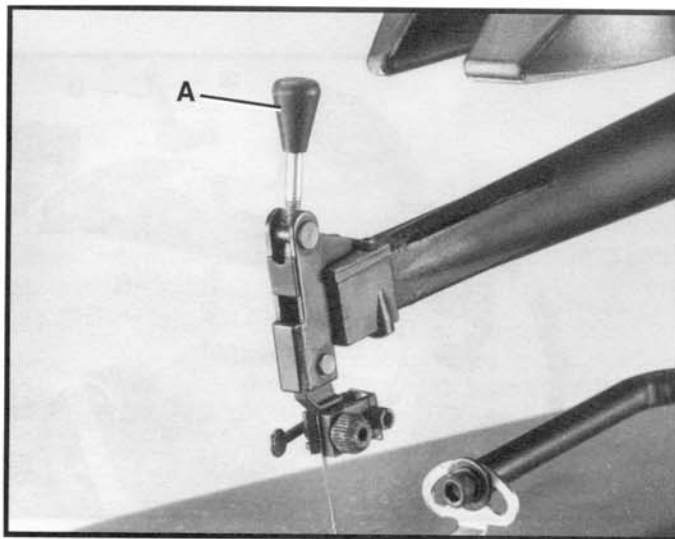

Fig. 21

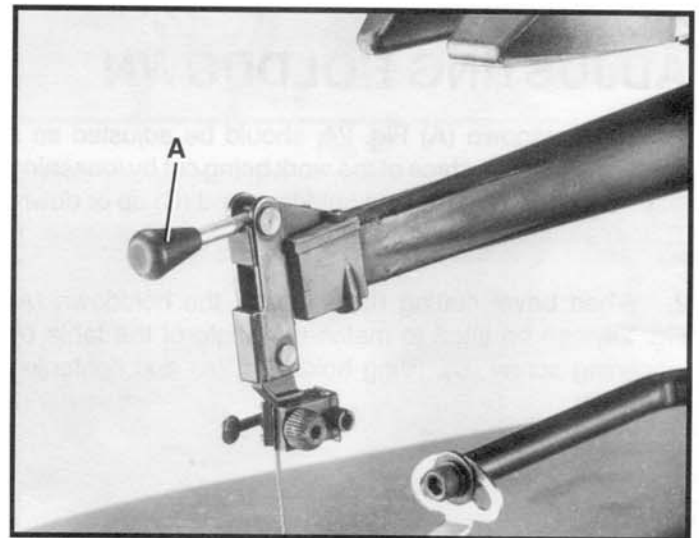

Fig. 22

Tension is applied to the blade when the blade tension lever (A) Fig. 21, is in the up position, as shown. When the lever (A) is moved forward, as shown in Fig. 22, blade tension is released.

To increase blade tension, turn tension lever (A) Fig. 21, clockwise, and to decrease blade tension, turn tension lever (A) counterclockwise. **When adjusting blade tension, tension lever (A) Fig. 20, should be in the full forward position as shown. It is only necessary to adjust blade tension knob (A) when a different type of blade is assembled to the blade holders.** It is not necessary to adjust blade tension when the blade is removed from, and replaced in only the upper blade holder as in performing inside cutting operations. Adjusting the blade for proper tension is usually accomplished by trial and error; however, a good method to use is to pluck the rear of the blade like a guitar string, after the tension lever (A) Fig. 22, is moved to the rear. A high-pitched tone of the blade should be heard and this usually indicates proper tension. Thicker blades require more tensioning (a higher pitched sound) while finer blades require less tension.

ADJUSTING CLAMPING ACTION OF BLADE HOLDERS

Different widths of scroll saw blades will make it necessary to adjust the clamping action of the blade holders. It should be noted, however, that very little adjustment is necessary and very little clamping force is required to hold the blade satisfactorily. As a rule of thumb, looking down at the table with the table insert slot in the 6 o'clock position, resistance on the blade locking lever (A) Fig. 23, should be felt when the upper blade locking lever reaches the 7 o'clock position, or when the lower blade locking lever reaches the 5 o'clock position.

1. Move the blade holder locking lever (A) Fig. 23, to the rear (open) position, as shown.
2. Turn locknut (B) Fig. 23, clockwise to tighten and counterclockwise to loosen the clamping action of the blade holder. **VERY LITTLE MOVEMENT OF LOCKNUT (B) WILL BE NECESSARY.**
3. Adjust clamping action of lower blade holder in the same manner.

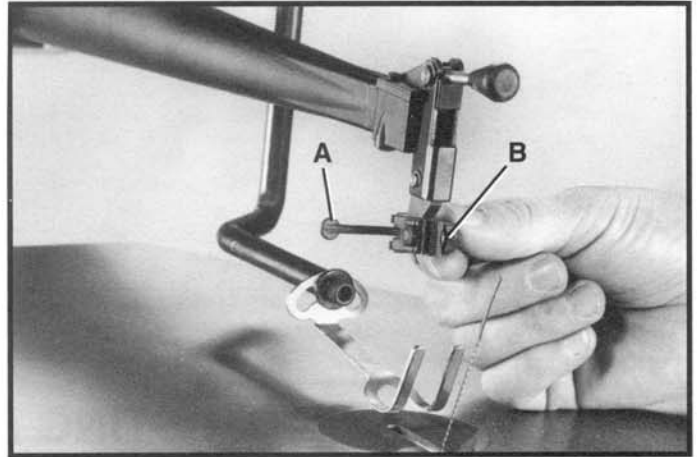

Fig. 23

ADJUSTING HOLDDOWN

1. The holddown (A) Fig. 24, should be adjusted so it contacts the top surface of the work being cut by loosening lock handle (B) and moving holddown rod (C) up or down. Then tighten lock handle (B).
2. When bevel cutting (table tilted), the holddown (A) Fig. 24, can be tilted to match the angle of the table by loosening screw (D), tilting holddown (A) and tightening screw (D).

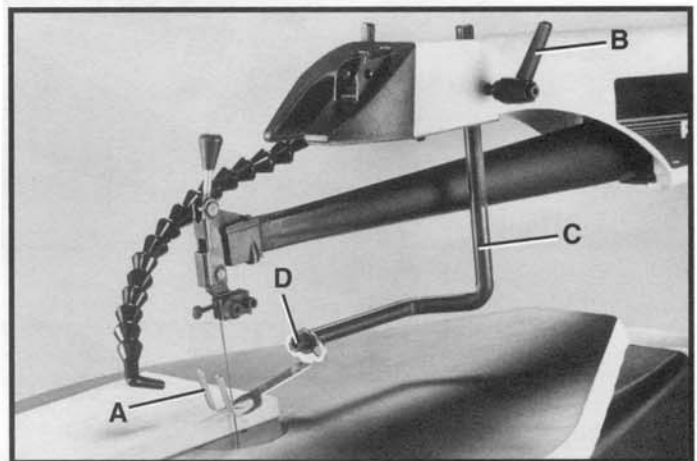

Fig. 24

CHANGING BLADES

1. **WARNING: TO AVOID INJURY FROM ACCIDENTAL STARTING, ALWAYS TURN SWITCH "OFF" AND REMOVE POWER CORD PLUG FROM ELECTRICAL OUTLET BEFORE REMOVING OR REPLACING BLADE.**
2. Remove table insert (A) Fig. 25, and release blade tension by pulling tension lever (B) forward, as shown.

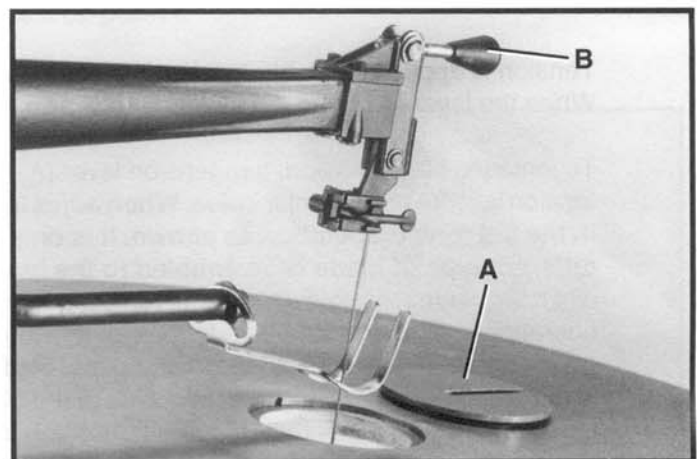

Fig. 25

3. Push blade holder locking lever (C) Fig. 26, to the rear as shown. This will automatically release the blade (D) from the upper blade holder (E).

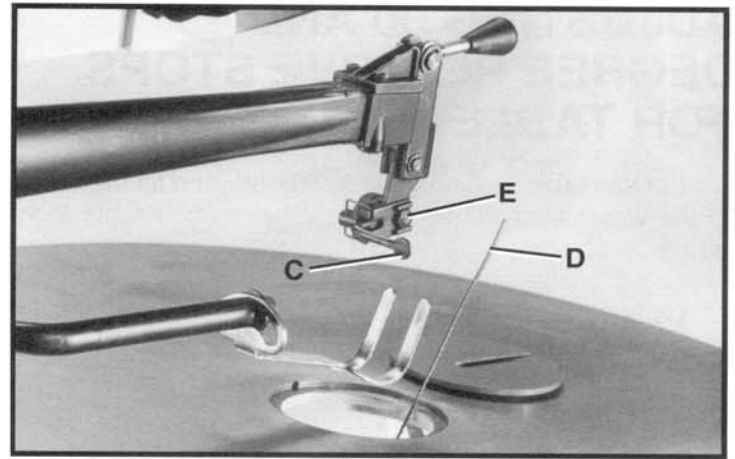

Fig. 26

4. Push lower blade holder locking lever (F) Fig. 27, to the rear. This will automatically release blade (D) from lower chuck.

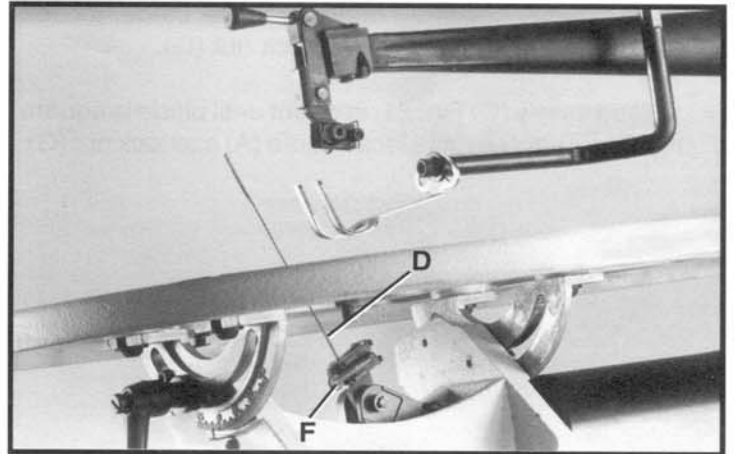

Fig. 27

5. Remove blade from lower chuck.

6. Insert new blade into the lower and upper blade holders in the same manner, making certain the blade teeth are pointing down toward the table, and secure blade in place by pulling blade holder locking levers (C) Fig. 26, and (F) Fig. 28, forward as shown.

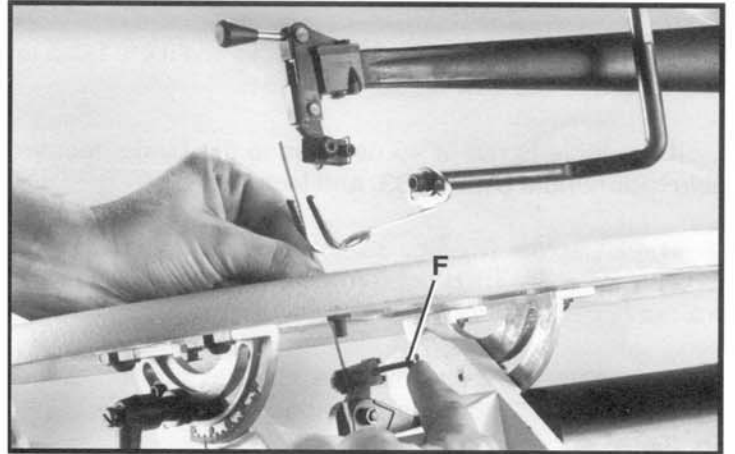

Fig. 28

7. Apply blade tension by referring to section, “**ADJUSTING BLADE TENSION.**”

TILTING THE TABLE

The table on your scroll saw can be tilted 45 degrees to the right and 15 degrees to the left for bevel cutting operations by loosening table lock handle (A) Fig. 29, tilt the table to the desired angle, and tighten lock handle (A). A scale and pointer (B) is provided to determine the angle of tilt.

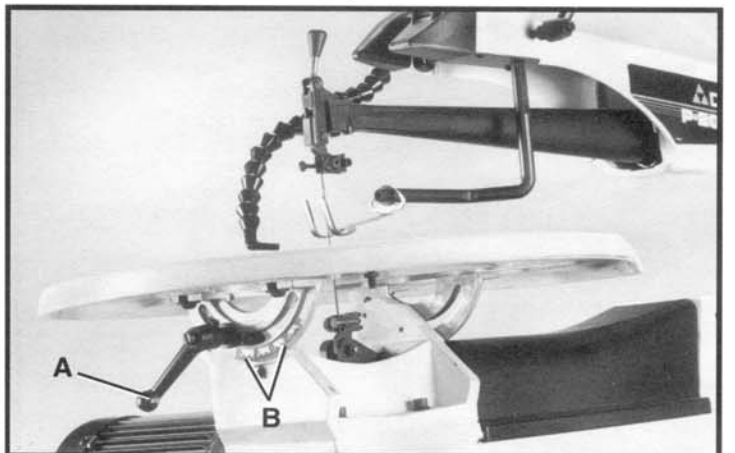

Fig. 29

ADJUSTING 90 AND 45 DEGREE POSITIVE STOPS FOR TABLE

1. Loosen table lock handle (A) Fig. 30, and tilt the table all the way to the left as shown, then tighten table lock handle.

2. Using a square (B) Fig. 30, check to see if the table is 90 degrees to the saw blade, as shown.

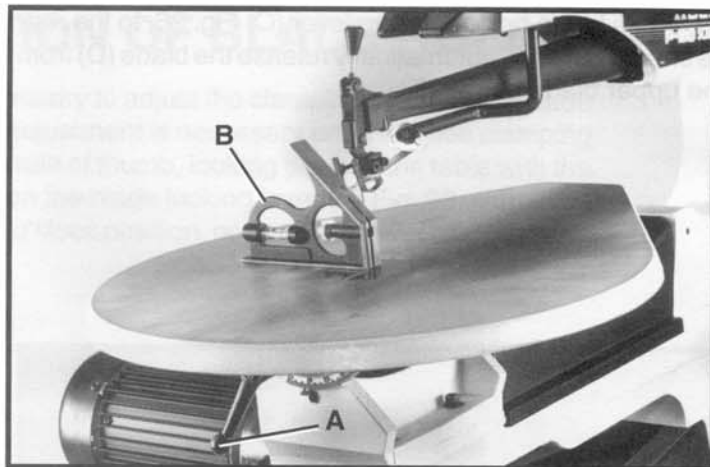

Fig. 30

3. If the table is not at 90 degrees to the blade, loosen table lock handle (A) Fig. 31, and lock nut (G).

4. Thread screw (C) Fig. 31, in or out until blade is square to table. Then tighten table lock handle (A) and lock nut (G).

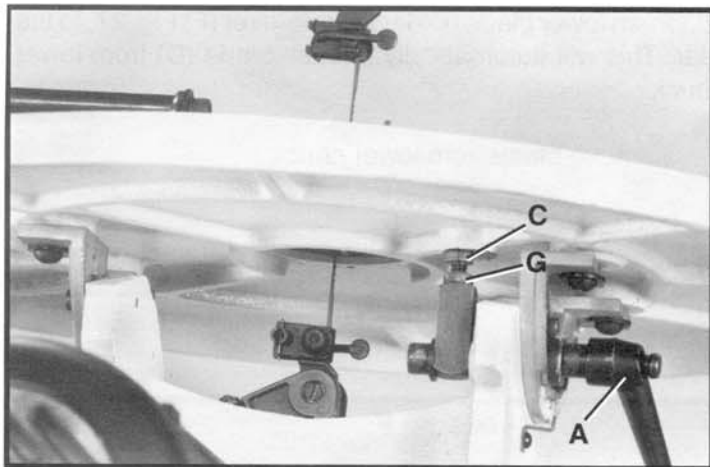

Fig. 31

5. Tilt table all the way to the right, as shown in Fig. 32, and tighten table lock handle (A).

6. Using a square (B) Fig. 32, check to see if the table is 45 degrees to the saw blade, as shown.

7. If the table is not at 45 degrees to the blade, loosen table lock handle (A) Fig. 33, and lock nut (D).

8. Thread screw (E) Fig. 33, in or out until blade is 45 degrees to table. Then tighten table lock handle (A) and lock nut (E).

9. If desired, the table may be tilted to the left up to approximately 15 degrees by repositioning flip stop (F) Fig. 34, as shown.

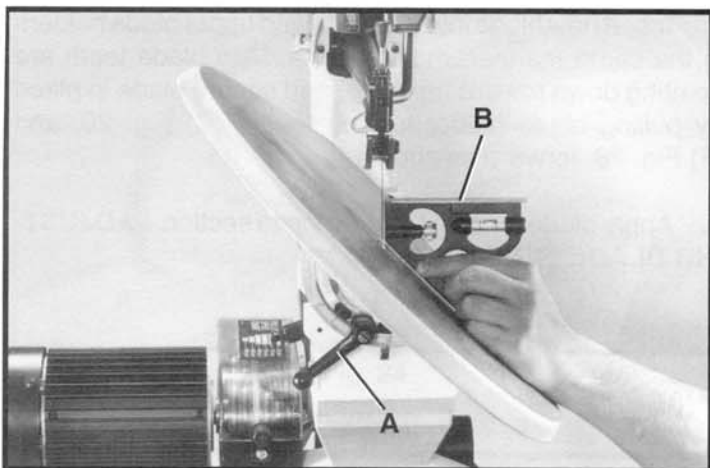

Fig. 32

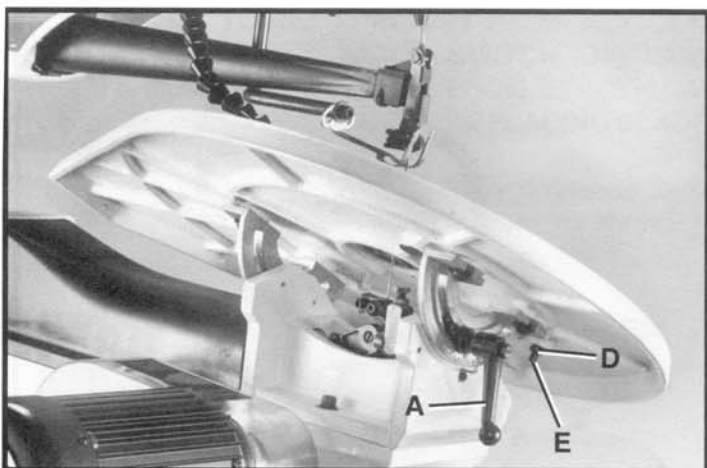

Fig. 33

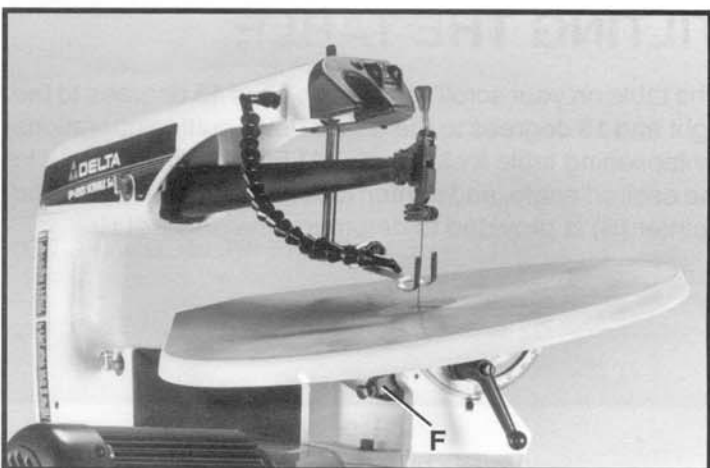

Fig. 34

ALIGNING LOWER BLADE HOLDER WITH UPPER BLADE HOLDER

The lower blade holder is set at the factory to be in alignment with the upper blade holder. To check the alignment, proceed as follows:

1. **MAKE CERTAIN THE MACHINE IS DISCONNECTED FROM THE POWER SOURCE.**
2. Rotate knob (A) Fig. 35, clockwise to disengage latch (B) from screw (C) and lift top cover (D) as shown.

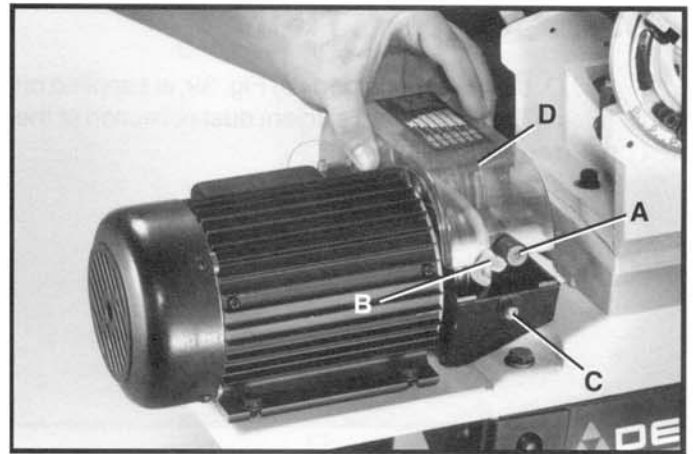

Fig. 35

3. Place a small straight edge (E) Fig. 36, onto the saw table so the end of straight edge (E) is against the side of the saw blade (G) as shown.

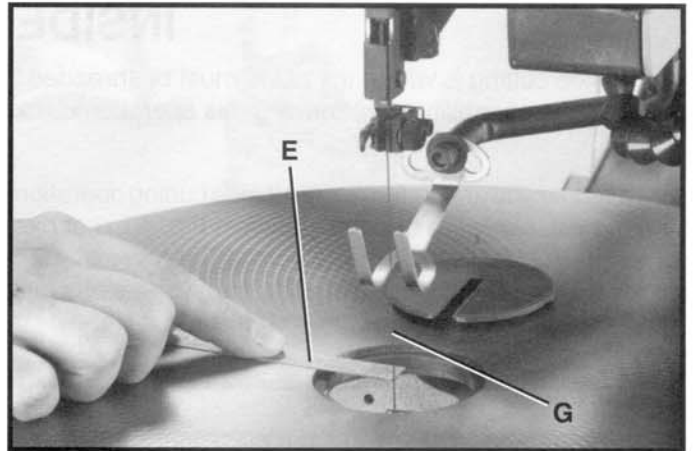

Fig. 36

4. While holding down on straight edge (E) Fig. 36, slowly rotate motor pulley (not shown) to move blade (G) up and down. Blade (G) should contact end of straight edge (E) during the entire stroke. If consistent contact of the blade is made during the entire stroke, replace top cover which was removed in **STEP 2**. If the blade does not contact the straight edge during the entire stroke, adjust screw (H) Fig. 37, to move the lower blade holder left or right until consistent contact of the blade is made during the entire stroke. Then replace top cover which was removed in **STEP 2**.



Fig. 37

LUBRICATION

To keep the scroll saw operating at peak efficiency, we strongly recommend that a simple maintenance procedure be performed after approximately every 20 hours of use. Proceed as follows:

1. **MAKE CERTAIN THE MACHINE IS DISCONNECTED FROM THE POWER SOURCE.**
2. Open caps of oil cups (A) Fig. 38, and place a few drops of light machine oil into each cup as shown.



Fig. 38

DUST COLLECTION

A 2-1/4" O.D. dust collection port (B) Fig. 39, is supplied on the 20" Scroll Saw to provide efficient dust collection of the dust produced by the saw.

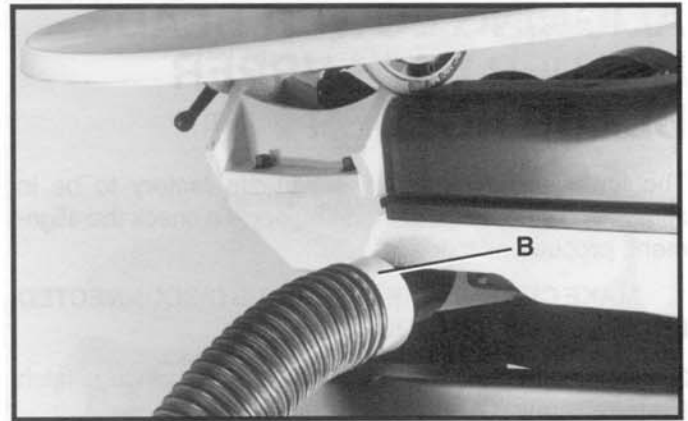

Fig. 39

INSIDE CUTTING

Inside cutting is where the blade must be threaded through a hole in the workpiece. The Delta 20" Scroll Saw has the capability of performing this operation quickly and easily as follows:

Let's assume you are performing an inside cutting operation on a project, similar to the one shown in Fig. 40, that has numerous inside cuts to be made. This can be accomplished quickly with the Delta saw. In Fig. 40, the operator has just completed one of the inside cuts and must move to the next hole.

Loosen lock handle (A) Fig. 41, and raise spring holddown (B). Tighten lock handle (A). Release blade tension by moving tension lever (C) forward and loosen upper blade holder by moving lever (D) to the rear position as shown. This will release the blade (E).

Raise upper arm (F) as far as it will go until it stops.

Insert blade (E) Fig. 41, into the next hole in the pattern which needs to be cut as shown.

Press upper arm release lever (G) Fig. 42, and lower upper arm (F) as shown.

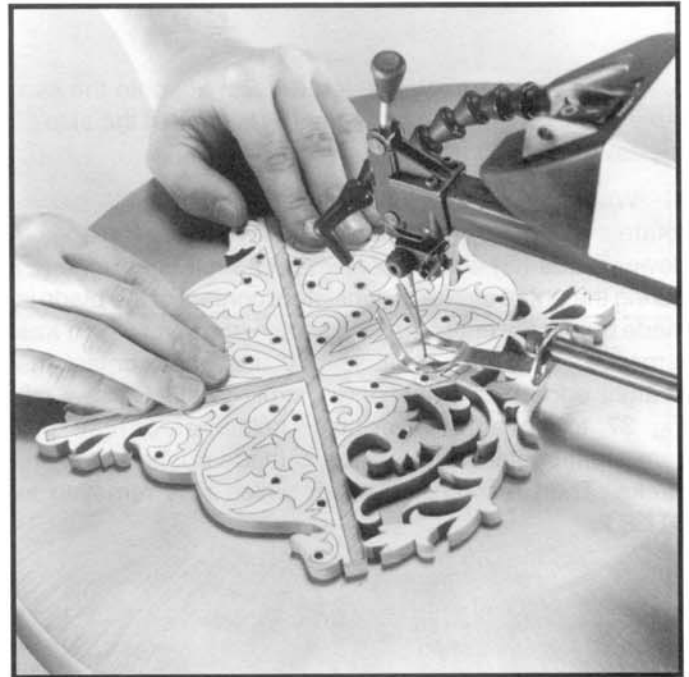

Fig. 40

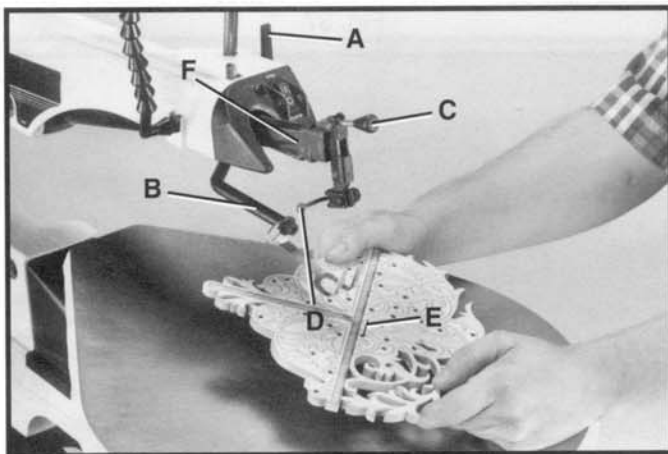

Fig. 41



Fig. 42

Reassemble blade (E) Fig. 43, back into the upper blade holder and tighten blade by moving lever (D) forward. Move tension lever (C) to the rear as shown and lower spring holddown (B). You are ready to make the next inside cut.

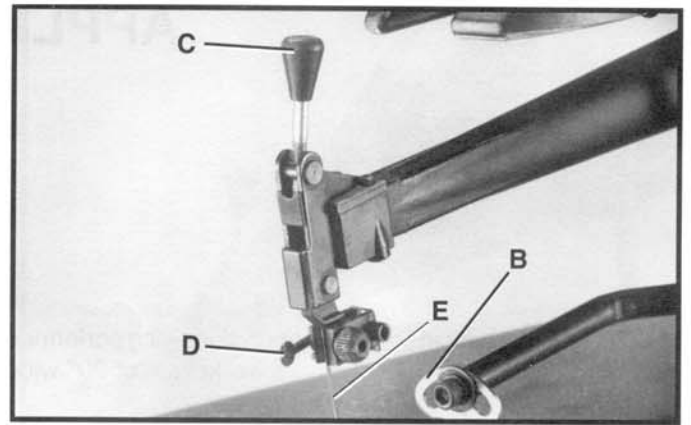

Fig. 43

BLADE BREAKAGE

Blade breakage is usually caused by one or more of the following:

1. Bending the blade during installation.
2. Improper blade tension.
3. Improper blade selection for the work being cut.
4. Forcing the work into the blade too rapidly.
5. Cutting too sharp a turn for the blade being used.
6. Improper blade speed.

When the blade breaks during operation, upper arm (A) Fig. 44, will automatically position itself as shown. To release upper arm (A) Fig. 45, turn saw off and simply press upper arm release lever (B) and press down on upper arm as shown.

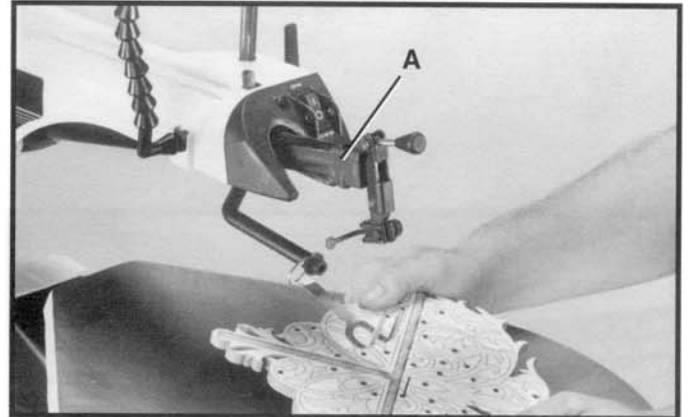

Fig. 44

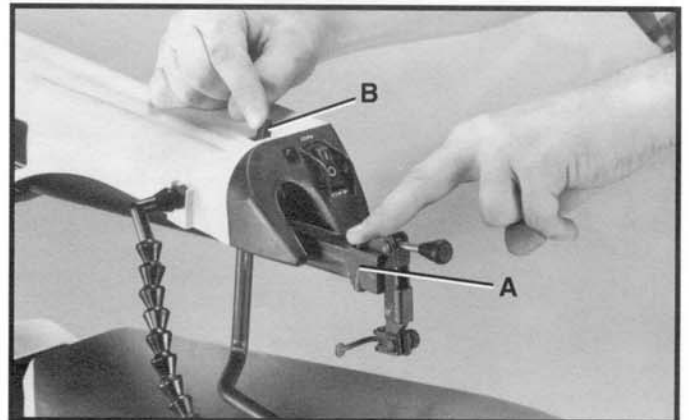

Fig. 45

CHOICE OF BLADE AND SPEED

Your scroll saw will accept a wide variety of 5" flat end blades and can be operated at 400, 700, 1200, 1400, 1600, or 2000 cutting strokes per minute. Consider the following as a general guideline for selecting a blade and operating speed.

1. Use a finer blade for cutting thin workpieces, for hard materials, or when a smoother cut is required.
2. Use a coarser blade for cutting thick workpieces, when making straight cuts or for medium to soft materials.
3. Use a blade that will have 2 teeth in the workpiece at all times.
4. Most blade packaging is marked with the size of the wood the blade is intended to cut and the minimum radius which can be cut with that blade.
5. Slower speeds are generally more effective than faster speeds when using thin blades and making intricate cuts.
6. Always start at a slow speed and gradually increase the speed until the optimum cutting speed is obtained.

(See your local Delta distributor for a full line of Scroll Saw blades).

APPLICATIONS

Fig. 46, shows a typical scroll saw operation being performed on a large workpiece. A maximum workpiece of 20" wide will fit between the blade and the rear of saw.



Fig. 46

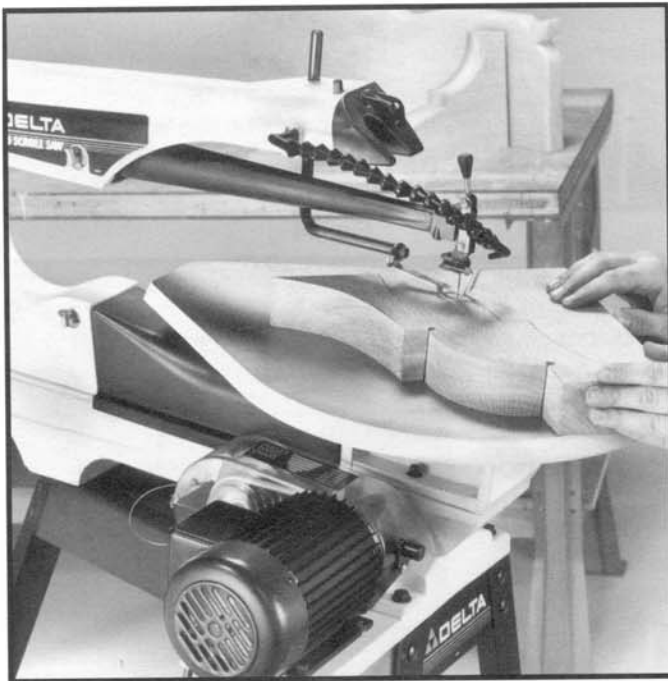

Fig. 47

Fig. 47, displays the maximum thickness of 2" being cut on a shelf bracket.

Fig. 48, shows the table tilted and a bevel being cut on a picture frame.

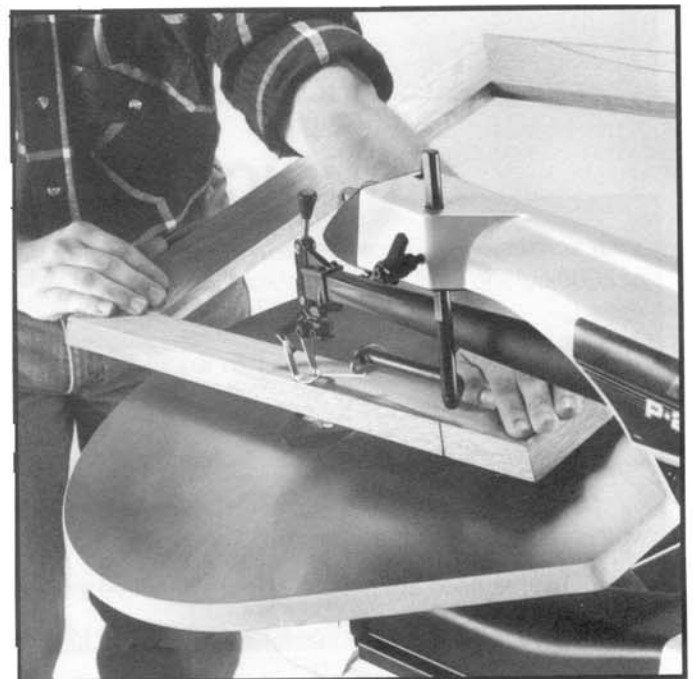

Fig. 48

Fig. 49, shows intricate cuts being performed into a metal workpiece. **NOTE:** The cutting speed is normally set at 400 cuts per minute when cutting metals.

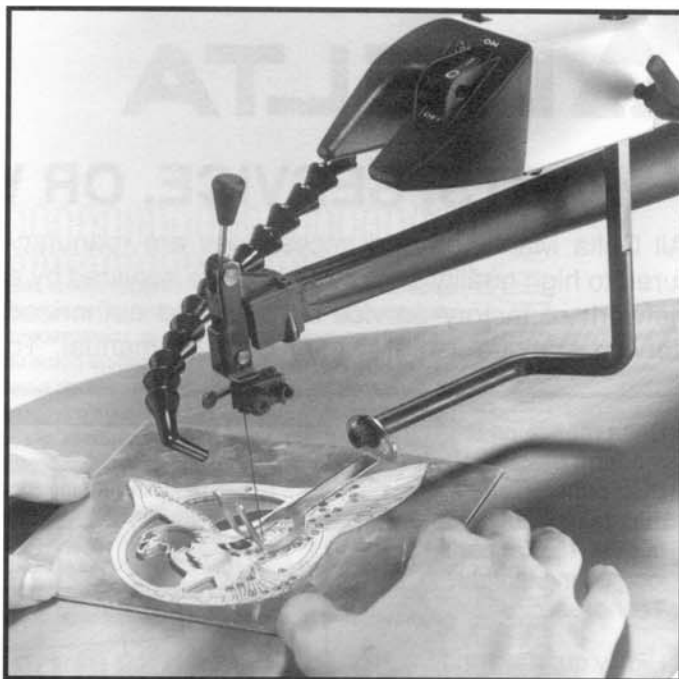

Fig. 49

ZERO-CLEARANCE TABLE INSERT

A table insert blank (B) Fig. 50, is supplied as standard equipment with your scroll saw and can be used when cutting very small workpieces to give added support to the bottom of the workpiece. Simply cut a slot into the blank and replace the standard insert (A) with the blank (B). The slot cut into the blank (B) will only be as wide as the blade, giving maximum support to the bottom of the workpiece.

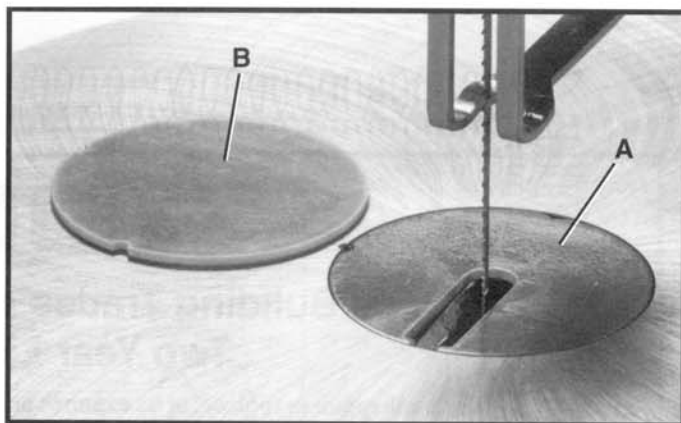

Fig. 50

SERIAL NUMBER LOCATION

The serial number is located on the right side of the base casting. Copy this number onto the front of this manual for future reference.

ACCESSORIES

A complete line of accessories is available from your Delta Supplier, Porter-Cable • Delta Factory Service Centers, and Delta Authorized Service Stations. Please visit our Web Site www.deltamachinery.com for a catalog or for the name of your nearest supplier.

▲ WARNING Since accessories other than those offered by Delta have not been tested with this product, use of such accessories could be hazardous. For safest operation, only Delta recommended accessories should be used with this product.



PARTS, SERVICE OR WARRANTY ASSISTANCE

All Delta Machines and accessories are manufactured to high quality standards and are serviced by a network of Porter-Cable • Delta Factory Service Centers and Delta Authorized Service Stations. To obtain additional information regarding your Delta quality product or to obtain parts, service, warranty assistance, or the location of the nearest service outlet, please call 1-800-223-7278 (In Canada call 1-800-463-3582).



Two Year Limited New Product Warranty

Delta will repair or replace, at its expense and at its option, any new Delta machine, machine part, or machine accessory which in normal use has proven to be defective in workmanship or material, provided that the customer returns the product prepaid to a Delta factory service center or authorized service station with proof of purchase of the product within two years and provides Delta with reasonable opportunity to verify the alleged defect by inspection. For all refurbished Delta product, the warranty period is 180 days. Delta may require that electric motors be returned prepaid to a motor manufacturer's authorized station for inspection and repair or replacement. Delta will not be responsible for any asserted defect which has resulted from normal wear, misuse, abuse or repair or alteration made or specifically authorized by anyone other than an authorized Delta service facility or representative. Under no circumstances will Delta be liable for incidental or consequential damages resulting from defective products. This warranty is Delta's sole warranty and sets forth the customer's exclusive remedy, with respect to defective products; all other warranties, express or implied, whether of merchantability, fitness for purpose, or otherwise, are expressly disclaimed by Delta.

PORTER-CABLE • DELTA SERVICE CENTERS (CENTROS DE SERVICIO DE PORTER-CABLE • DELTA)

Parts and Repair Service for Porter-Cable • Delta Machinery are Available at These Locations
(Obtenga Refaccion de Partes o Servicio para su Herramienta en los Siguientes Centros de Porter-Cable • Delta)

ARIZONA

Tempe 85282 (Phoenix)
2400 West Southern Avenue
Suite 105
Phone: (602) 437-1200
Fax: (602) 437-2200

CALIFORNIA

Ontario 91761 (Los Angeles)
3949A East Guasti Road
Phone: (909) 390-5555
Fax: (909) 390-5554

San Leandro 94577 (Oakland)
3039 Teagarden Street
Phone: (510) 357-9762
Fax: (510) 357-7939

COLORADO

Arvada 80003 (Denver)
8175 Sheridan Blvd., Unit S
Phone: (303) 487-1809
Fax: (303) 487-1868

FLORIDA

Davie 33314 (Miami)
4343 South State Rd. 7 (441)
Unit #107
Phone: (954) 321-6635
Fax: (954) 321-6638

Tampa 33609
4538 W. Kennedy Boulevard
Phone: (813) 877-9585
Fax: (813) 289-7948

GEORGIA

Forest Park 30297 (Atlanta)
5442 Frontage Road,
Suite 112
Phone: (404) 608-0006
Fax: (404) 608-1123

ILLINOIS

Addison 60101 (Chicago)
400 South Rohlwing Rd.
Phone: (630) 424-8805
Fax: (630) 424-8895

Woodridge 60517 (Chicago)
2033 West 75th Street
Phone: (630) 910-9200
Fax: (630) 910-0360

MARYLAND

Elkridge 21075 (Baltimore)
7397-102 Washington Blvd.
Phone: (410) 799-9394
Fax: (410) 799-9398

MASSACHUSETTS

Braintree 02185 (Boston)
719 Granite Street
Phone: (781) 848-9810
Fax: (781) 848-6759

Franklin 02038 (Boston)
Franklin Industrial Park
101E Constitution Blvd.
Phone: (508) 520-8802
Fax: (508) 528-8089

MICHIGAN

Madison Heights 48071 (Detroit)
30475 Stephenson Highway
Phone: (248) 597-5000
Fax: (248) 597-5004

MINNESOTA

Minneapolis 55429
5522 Lakeland Avenue North
Phone: (763) 561-9080
Fax: (763) 561-0653

MISSOURI

North Kansas City 64116
1141 Swift Avenue
Phone: (816) 221-2070
Fax: (816) 221-2897

St. Louis 63119
7574 Watson Road
Phone: (314) 968-8950
Fax: (314) 968-2790

NEW YORK

Flushing 11365-1595 (N.Y.C.)
175-25 Horace Harding Expwy.
Phone: (718) 225-2040
Fax: (718) 423-9619

NORTH CAROLINA

Charlotte 28270
9129 Monroe Road, Suite 115
Phone: (704) 841-1176
Fax: (704) 708-4625

OHIO

Columbus 43214
4560 Indianola Avenue
Phone: (614) 263-0929
Fax: (614) 263-1238

Cleveland 44125
8001 Sweet Valley Drive
Unit #19
Phone: (216) 447-9030
Fax: (216) 447-3097

OREGON

Portland 97230
4916 NE 122 nd Ave.
Phone: (503) 252-0107
Fax: (503) 252-2123

PENNSYLVANIA

Willow Grove 19090
520 North York Road
Phone: (215) 658-1430
Fax: (215) 658-1433

TEXAS

Carrollton 75006 (Dallas)
1300 Interstate 35 N, Suite 112
Phone: (972) 446-2996
Fax: (972) 446-8157

Houston 77038
4321 Sam Houston Parkway,
West
Suite 180
Phone: (281) 260-8887
Fax: (281) 260-9989

WASHINGTON

Auburn 98001 (Seattle)
3320 West Valley HWY, North
Building D, Suite 111
Phone: (253) 333-8353
Fax: (253) 333-9613

Authorized Service Stations are located in many large cities. Telephone **800-438-2486** or **731-541-6042** for assistance locating one. Parts and accessories for Porter-Cable•Delta products should be obtained by contacting any Porter-Cable•Delta Distributor, Authorized Service Center, or Porter-Cable•Delta Factory Service Center. If you do not have access to any of these, call **800-223-7278** and you will be directed to the nearest Porter-Cable•Delta Factory Service Center. Las Estaciones de Servicio Autorizadas están ubicadas en muchas grandes ciudades. Llame al **800-438-2486** ó al **731-541-6042** para obtener asistencia a fin de localizar una. Las piezas y los accesorios para los productos Porter-Cable•Delta deben obtenerse poniéndose en contacto con cualquier distribuidor Porter-Cable•Delta, Centro de Servicio Autorizado o Centro de Servicio de Fábrica Porter-Cable•Delta. Si no tiene acceso a ninguna de estas opciones, llame al **800-223-7278** y le dirigirán al Centro de Servicio de Fábrica Porter-Cable•Delta más cercano.

CANADIAN PORTER-CABLE • DELTA SERVICE CENTERS

ALBERTA

Bay 6, 2520-23rd St. N.E.
Calgary, Alberta
T2E 8L2
Phone: (403) 735-6166
Fax: (403) 735-6144

BRITISH COLUMBIA

8520 Baxter Place
Burnaby, B.C.
V5A 4T8
Phone: (604) 420-0102
Fax: (604) 420-3522

MANITOBA

1699 Dublin Avenue
Winnipeg, Manitoba
R3H 0H2
Phone: (204) 633-9259
Fax: (204) 632-1976

ONTARIO

505 Southgate Drive
Guelph, Ontario
N1H 6M7
Phone: (519) 767-4132
Fax: (519) 767-4131

QUÉBEC

1515 ave.
St-Jean Baptiste, Suite 160
Québec, Québec
G2E 5E2
Phone: (418) 877-7112
Fax: (418) 877-7123

1447, Begin
St-Laurent, (Montréal),
Québec
H4R 1V8
Phone: (514) 336-8772
Fax: (514) 336-3505

The following are trademarks of PORTER-CABLE-DELTA (Las siguientes son marcas registradas de PORTER-CABLE S.A.): Auto-Set®, BAMMER®, B.O.S.S.®, Builder's Saw®, Contractor's Saw®, Contractor's Saw II™, Delta®, DELTACRAFT®, DELTAGRAM™, Delta Series 2000™, DURATRONIC™, Emc2™, FLEX®, Flying Chips™, FRAME SAW®, Homecraft®, INNOVATION THAT WORKS®, Jet-Lock®, JETSTREAM®, 'kickstand', LASERLOC®, MICRO-SET®, Micro-Set®, MIDI LATHE®, MORTEN™, NETWORK™, OMNIJIG®, POCKET CUTTER®, PORTA-BAND®, PORTA-PLANE®, PORTER-CABLE®&(design), PORTER-CABLE®PROFESSIONAL POWER TOOLS, Posi-Matic®, Q-3®&(design), QUICKSAND®&(design), QUICKSET™, QUICKSET II®, QUICKSET PLUS™, RIPTIDE™&(design), SAFE GUARD II®, SAFE-LOC®, Sanding Center®, SANDTRAP®&(design), SAW BOSS®, Sawbuck™, Sidekick®, SPEEDMATIC®, SPEEDTRONIC®, STAIR EASE®, The American Woodshop®&(design), The Lumber Company®&(design), THE PROFESSIONAL EDGE®, THE PROFESSIONAL SELECT®, THIN-LINE™, TIGER®, TIGER CUB®, TIGER SAW®, TORQBUSTER®, TORQ-BUSTER®, TRU-MATCH™, TWIN-LITE®, UNIGUARD®, Unifence®, UNIFEEDER™, Unihead®, Uniplane™, Unirip®, Unisaw®, Univise®, Versa-Feeder®, VERSA-PLANE®, WHISPER SERIES®, WOODWORKER'S CHOICE™.

Trademarks noted with ™ and ® are registered in the United States Patent and Trademark Office and may also be registered in other countries. Las Marcas Registradas con el signo de ™ y ® son registradas por la Oficina de Registros y Patentes de los Estados Unidos y también pueden estar registradas en otros países.